

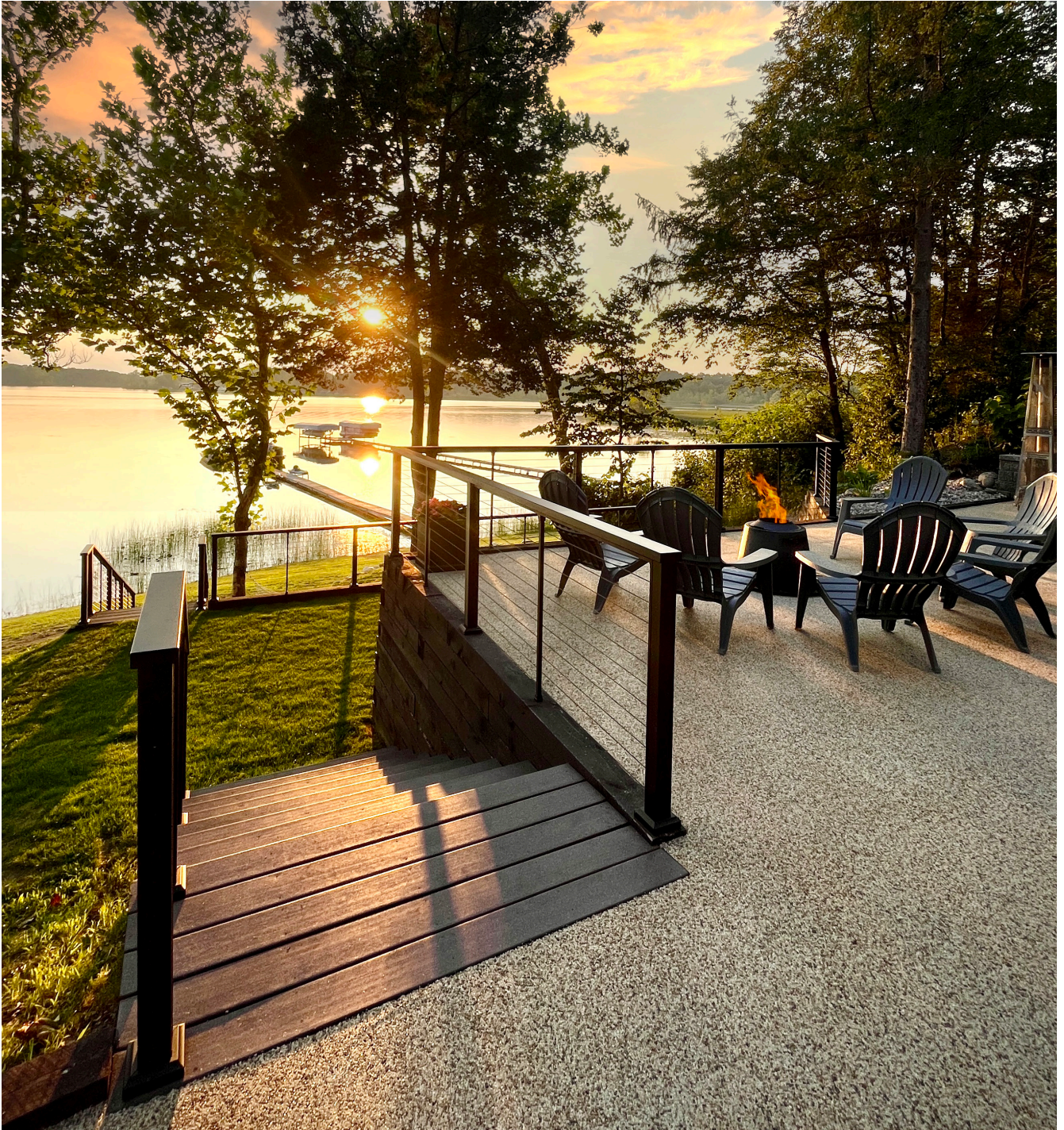

KEYLINK

PREMIER RAILING SYSTEMS





EXCEPTIONAL STYLE, OUTSTANDING PERFORMANCE.

If you're dreaming of **beautiful living** spaces, our low maintenance aluminum railing, designed to provide long-lasting attractiveness and safety, is one way to make that dream a reality. With its wide variety of colors and styles, Keylink's aluminum railing is appreciated by homeowners and builders alike. All of Keylink's railing is engineered to our exacting standards and fabricated and tested in the **USA**.

MANUFACTURED IN THE USA

Keylink's products are proudly designed and manufactured in the **USA** to ensure a quality fit and finish.

Pictured above: American Series Textured Black Railing with Horizontal Cable Infill

WHAT IS KEYLINK QUALITY?

- Keylink uses AAMA 2604 standard coating on all our aluminum, and AAMA 2605 standard coating is available as part of our coastal upgrade package, to protect aluminum within one mile of saltwater.
- IBC or IRC code compliance for peace of mind and safety
- Contractor focused design makes installation easy
- Access to dedicated support teams to assist your project
- Limited lifetime warranty and 5-year prorated labor warranty



Scan for
warranty
information



Keylink has been **PCI certified** through the Powder Coating Institute. Powder coating is the solution to keeping aluminum railing and fencing from fading and helping it to retain its color.

KEYLINK **CHESAPEAKE SERIES**

PRACTICAL. VERSATILE. CUSTOMIZABLE.

The Keylink Chesapeake series provides versatile style options to enhance your space's functionality and complement any lifestyle, whether you are entertaining family and friends or unwinding in your own personal oasis.





Textured White with Horizontal Cable



Textured Black with Square Balusters



Textured Black with Rod Rail & CAFRC



Matte Black with Vertical Cable

KEYLINK CHESAPEAKE SERIES

PRODUCT DETAILS

- Level and stair rail lengths come in 6' or 8' sections
- Available in 36" or 42" heights
- Meets IRC and IBC (42" only) code requirements
- Boxed sections include top and bottom rails, mounting brackets and hardware, 'infill' and the installation guide

*Except Horizontal Cable

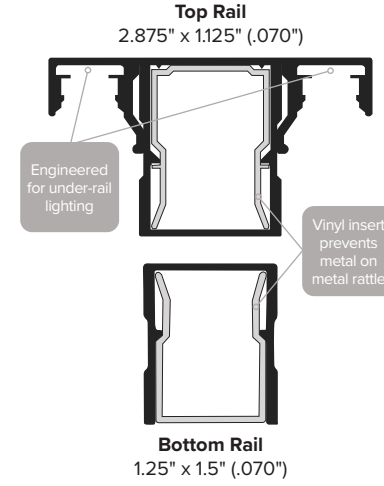

Chesapeake Aluminum Flat Rail Cap - CAFRC

- 17' lengths
- End cap, level alignment blocks, stair alignment blocks, optional beauty ring
- Available in all finishes

Alternative Top Rail

- Deck Board
- Wood
- Versatile Options

STANDARD COLORS

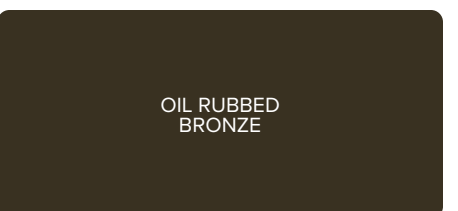
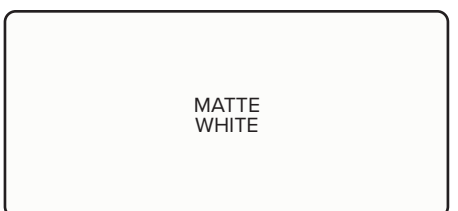
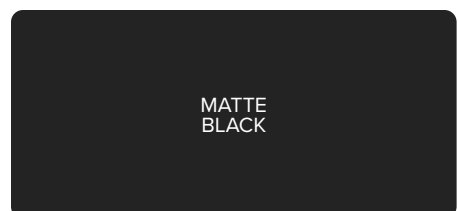

INFILL OPTIONS

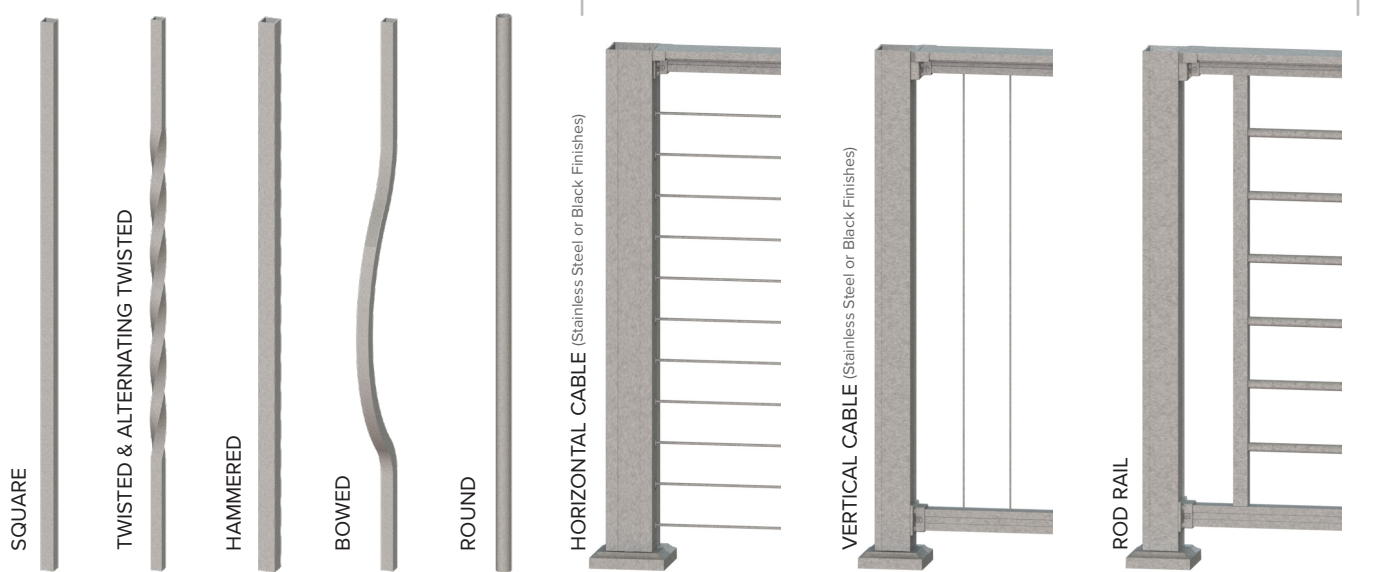

KEYLINK **AMERICAN SERIES**

ADAPTABLE. CLASSIC. ENDURING.

The Keylink American series is popular for its sophisticated, classic profile, and dynamic appearance. Whether you are hoping to preserve a more traditional style or are aiming for a more modern look, the options within the American series give you boundless opportunities for customization.





Textured Black with Vertical Cable



Barrier Railing



Oil Rubbed Bronze with Horizontal Cable



Matte White with Black Square Balusters



Textured Black with Horizontal Cable

KEYLINK AMERICAN SERIES

PRODUCT DETAILS

- Level and stair rail lengths come in 5', 6', 7' or 8' sections
- Available in 36" or 42" heights
- Meets IRC and IBC (42" only) code requirements
- Boxed sections include top and bottom rails, mounting brackets and hardware, infill and the installation guide

*Except Horizontal Cable

Top Rail
1.75" x 1.875" (.070")

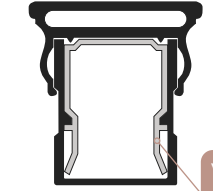

Vinyl insert prevents metal on metal rattle

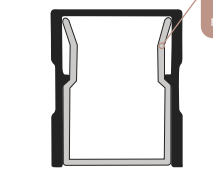

Bottom Rail
1.25" x 1.5" (.070")



- Crossover Posts Available**
- Line, corner and end post availability
 - Compatible for all infill options
 - Limited compatibility for horizontal cable



- Third Rail Options Available**
- Contemporary
 - Traditional

STANDARD COLORS

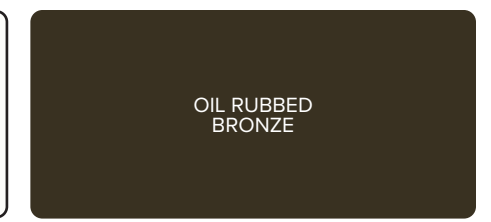
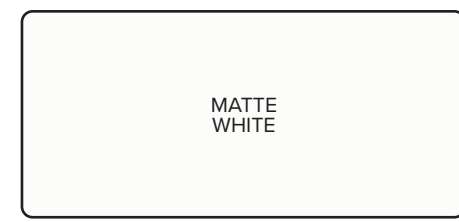
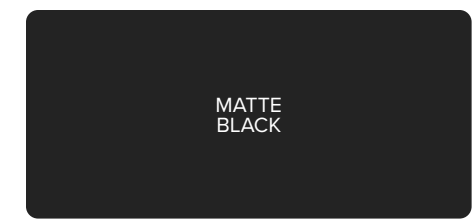
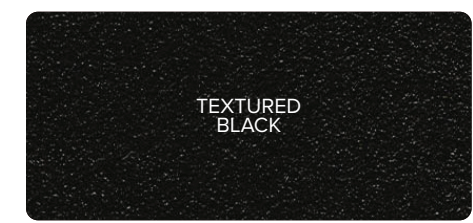

INFILL OPTIONS

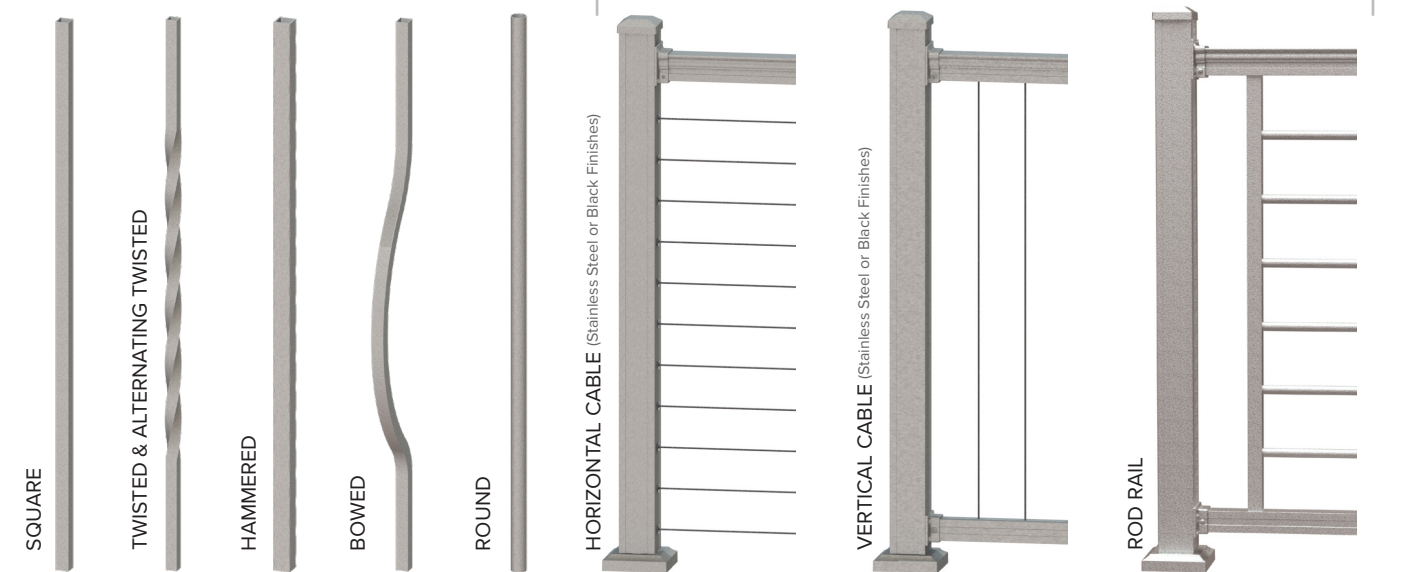

KEYLINK
OUTLOOK SERIES

REFINED. ELEGANT. MINIMALISTIC.

The Keylink Outlook series offers a slim, unobtrusive profile that complements virtually any design aesthetic. There is no sacrifice in safety, substance, or style with this simple, elegant railing system.





Textured Black with Square Balusters



Matte White with Square Balusters

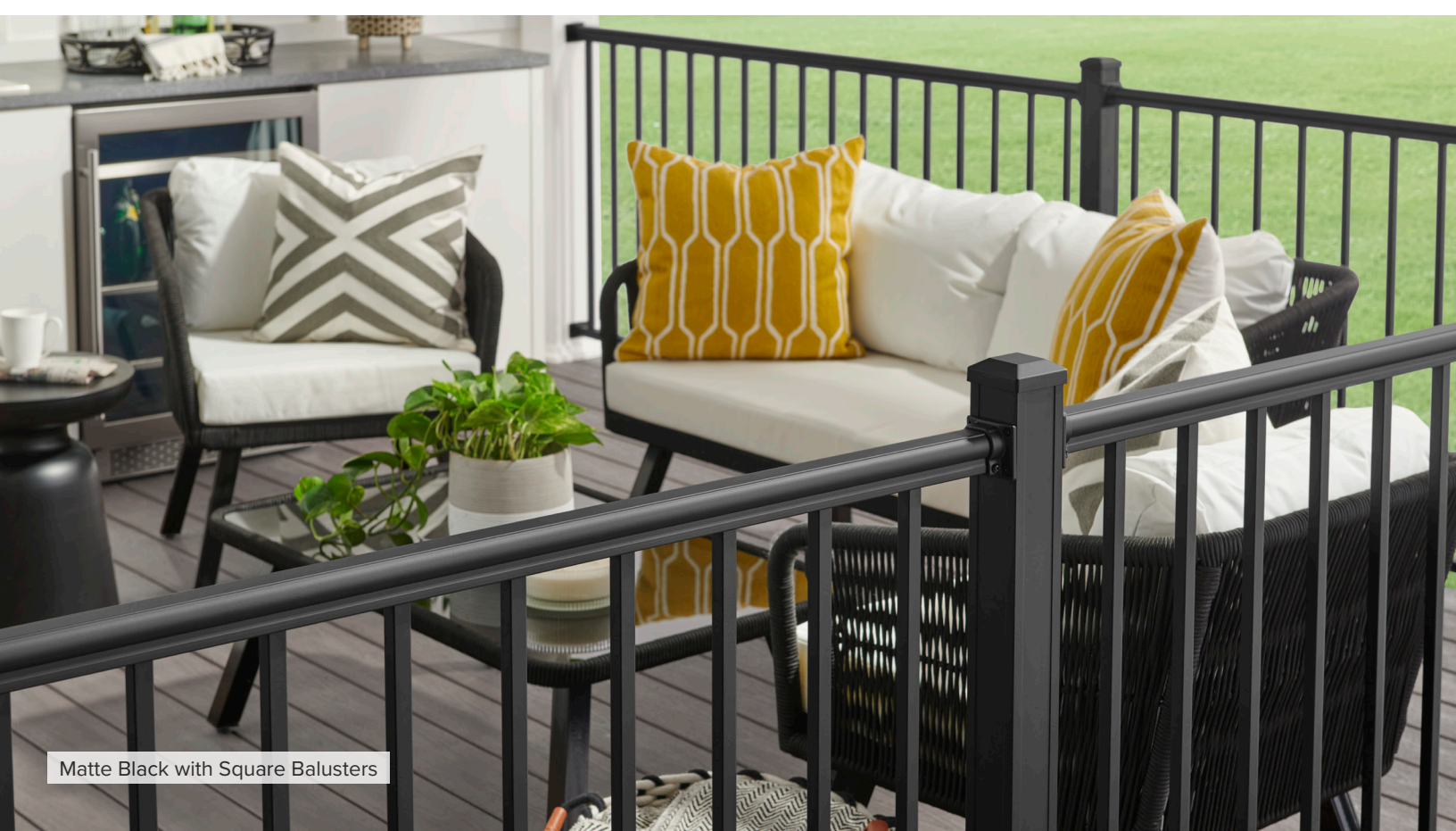

Matte Black with Square Balusters

KEYLINK OUTLOOK SERIES

PRODUCT DETAILS

- Level rail lengths come in 5', 6', 7' or 8' and stair rail lengths come in 4', 5' or 6'
- Available in 36" or 42" heights
- Meets IRC and IBC (42" only) code requirements
- Boxed sections include top and bottom rails, mounting brackets and hardware, infill and the installation guide

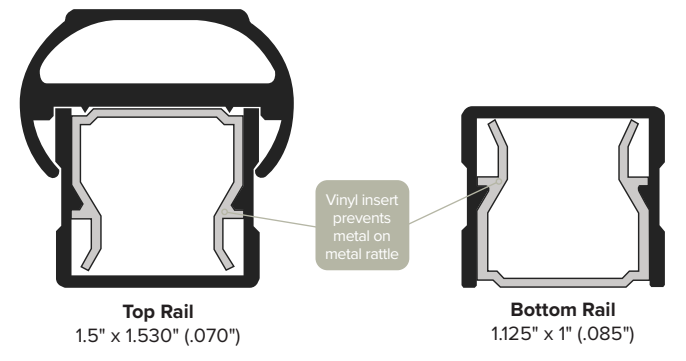

STANDARD COLORS

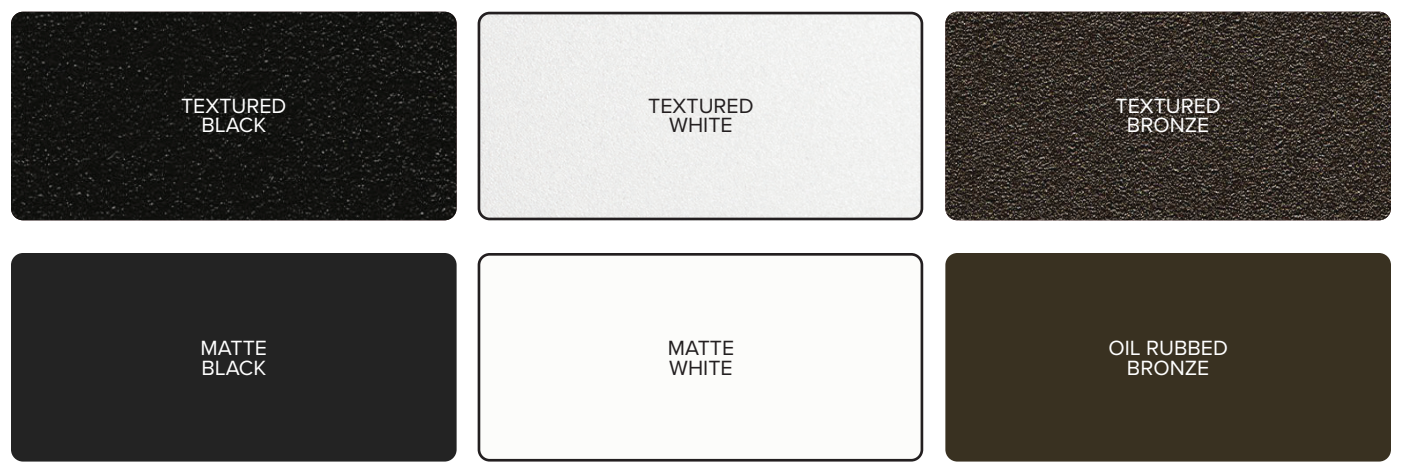

INFILL OPTION

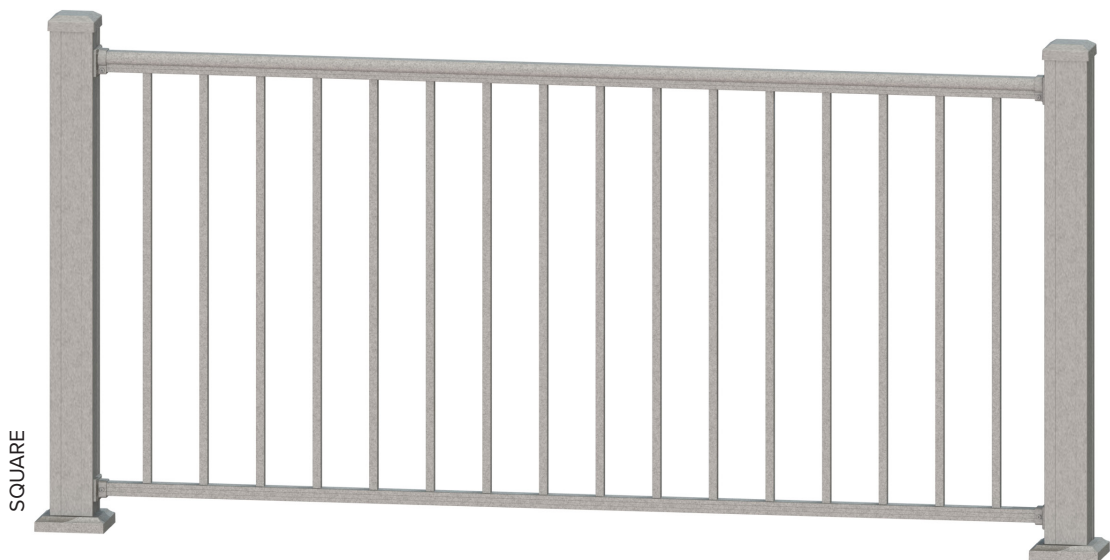

KEYLINK
DISCOVERY SERIES

TIMELESS. EFFICIENT. ECONOMICAL.

The Keylink Discovery series offers a timeless, low-maintenance railing system that combines efficiency with a sleek, modern appearance.



KEYLINK DISCOVERY SERIES

PRODUCT DETAILS

- Installs up to four times faster than pressure treated lumber
- Railing Length Options: 6', or 8'
- Railing Height Option: 36"
- Textured Black Only
- Square Balusters are 5/8"
- Boxed sections include top and bottom rails, infill and the installation guide

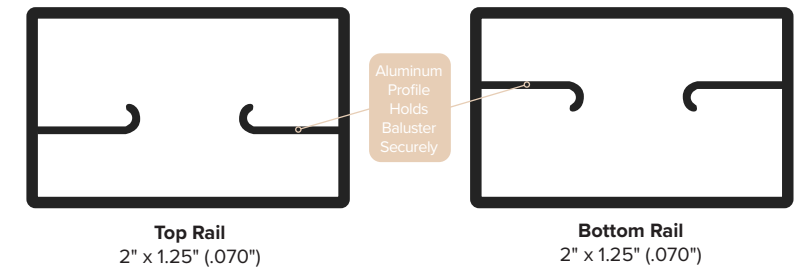

STANDARD COLOR



POSTS



INFILL OPTION

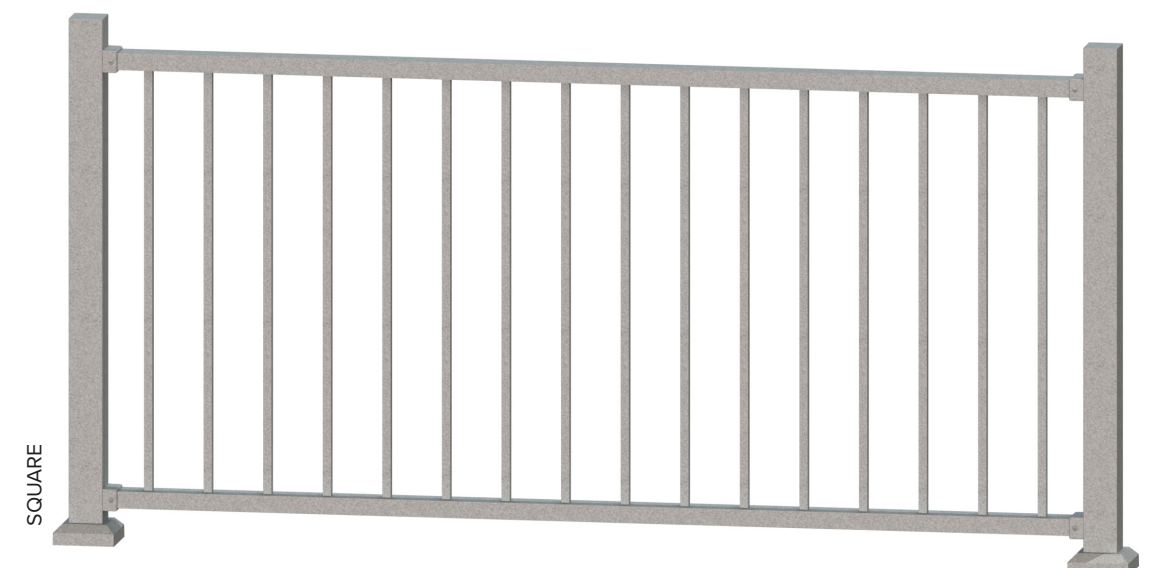

SERIES OVERVIEW

CHESAPEAKE SERIES

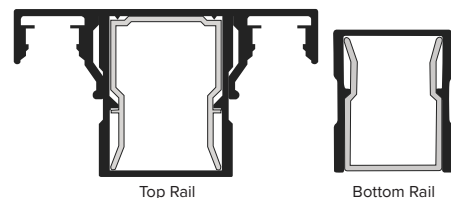

- Customizable Profile; Unlimited Rail Cap Options
- Functional, Practical for Entertaining
- Aesthetically Versatile
- Under Rail Lighting Compatible
- Exceeds IRC & IBC Compliance



AMERICAN SERIES

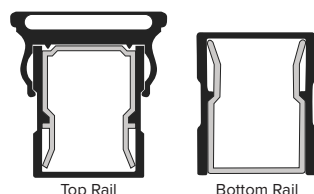

- Classic, Stylistically Adaptable Profile
- Aesthetically Versatile System
- Post-to-Post or Crossover Options
- Third Rail Options
- Exceeds IRC & IBC Compliance

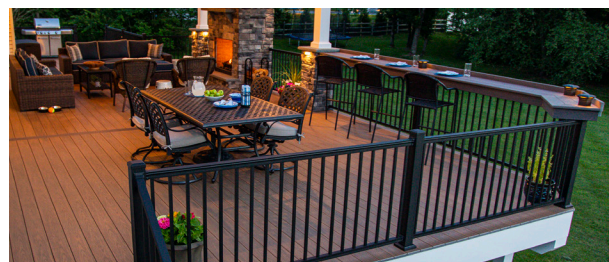

OUTLOOK SERIES

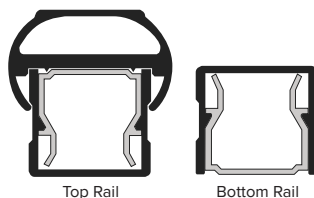

- Minimalistic, Slim, Round Profile
- Safety and Substance
- Simple Elegance
- Slimmer 5/8" Square Baluster
- Exceeds IRC & IBC Compliance



DISCOVERY SERIES

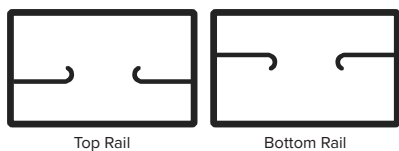

- Timeless, Clean, Square Profile
- Approximately 4 Times Faster to Install than Pressure-Treated Lumber
- Builder-Friendly Pre-Installed Brackets
- Exceeds IRC Compliance

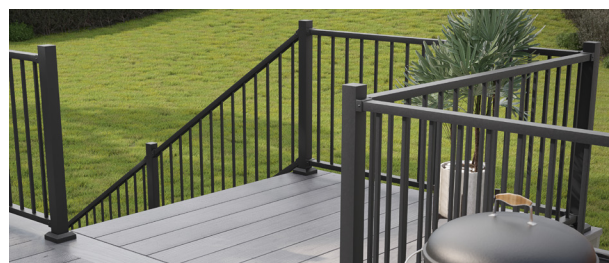

INFILL OPTIONS

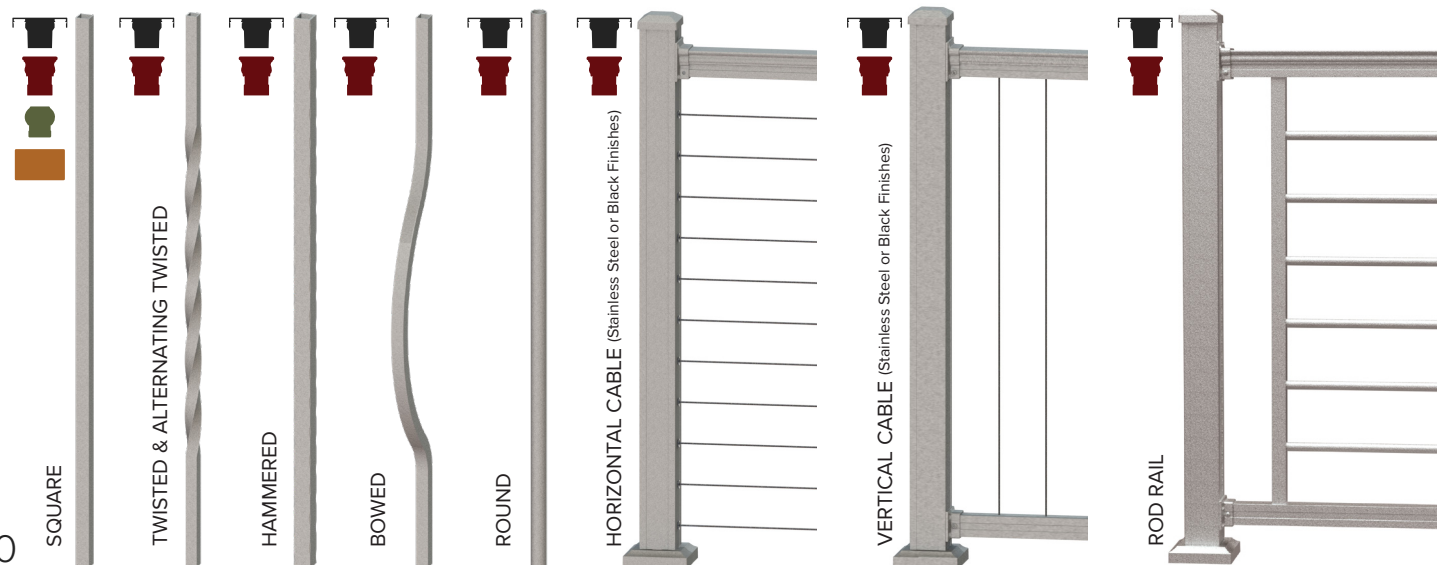

KEYLINK COLORS & FINISHES

KEYLINK'S STANDARD COLOR OPTIONS

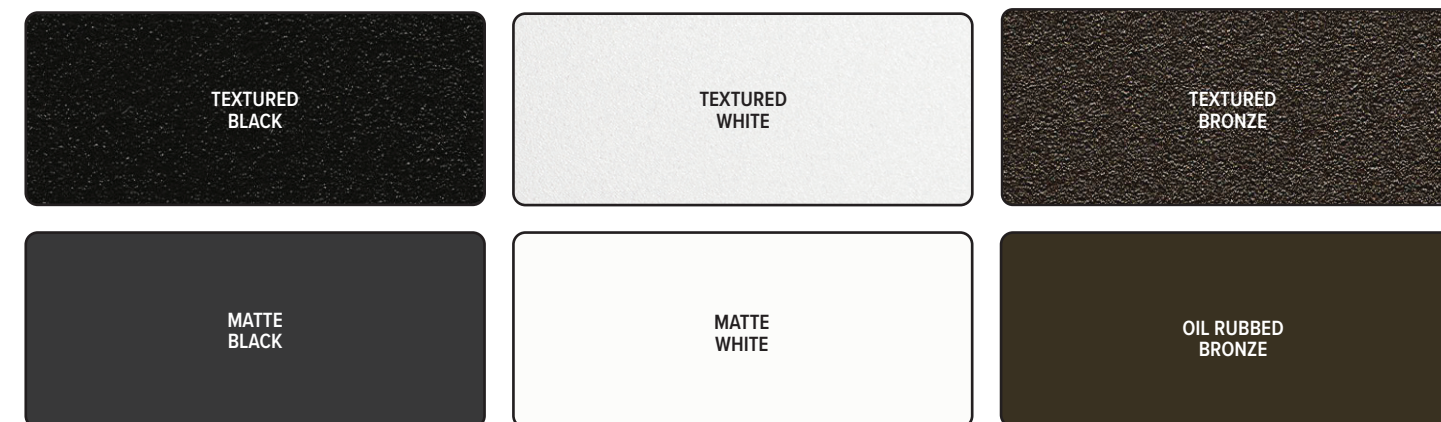

KEYLINK'S SPECIAL ORDER COLOR OPTIONS



S = Satin Finish
G = Gloss Finish



Scan the code to view our full collection of **colors and finishes** available for Special Order and Coastal Upgrade.

POWDER COATING STANDARDS

AAMA 2604 Standard Coating

Used on all Keylink products unless an upgrade is ordered. This level of protection balances effective coating with affordability, making it an excellent choice for outdoor aluminum.

AAMA 2605 Coating with Coastal Upgrade

Strongly recommended for installations near bodies of water, especially saltwater. This upgrade includes a primer over all the aluminum before it's finished with AAMA 2605 standard coating. The coastal upgrade protects the aluminum from galvanic corrosion. Please note that a slight difference in colors is expected between AAMA 2604 and AAMA 2605 finishes.



Keylink has received PCI-4000 Certification from the Powder Coating Institute, which is third-party confirmation that our process and coating meet the highest standards.

HORIZONTAL CABLE SYSTEM

Posts and support balusters come pre-drilled and pre-fitted for an even faster installation. Requires only single post at corners.

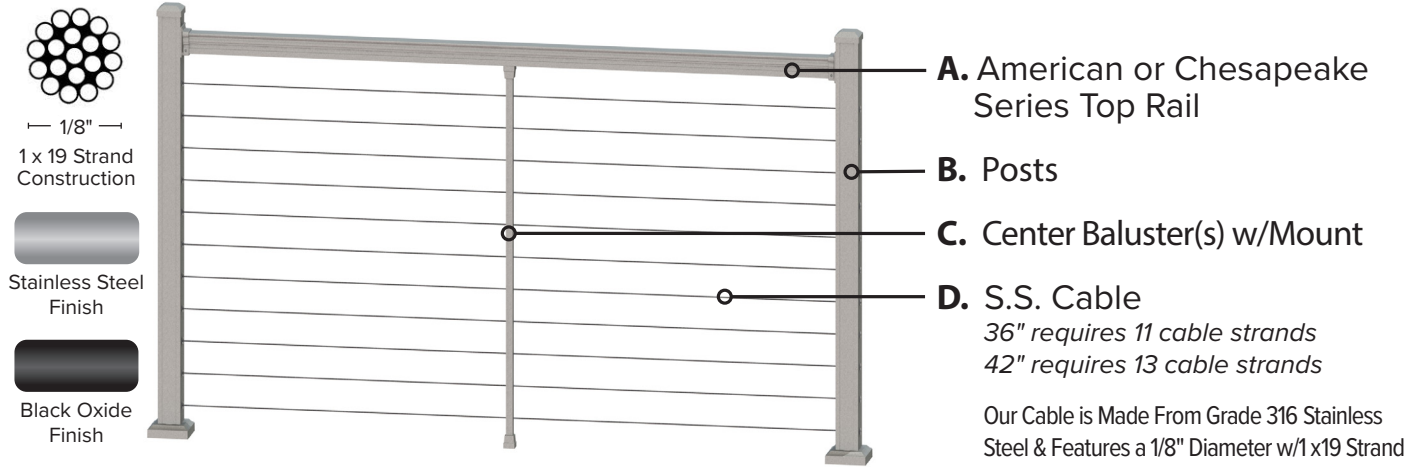

Boxed Section Includes: Top rail, intermediate baluster(s), baluster mounts, top rail mounting brackets with screws, and installation guide. Cable, posts, caps, and trim sold separately.

AVAILABLE POST OPTIONS

Horizontal cable posts are available with fittings in stainless steel or black oxide finishes.

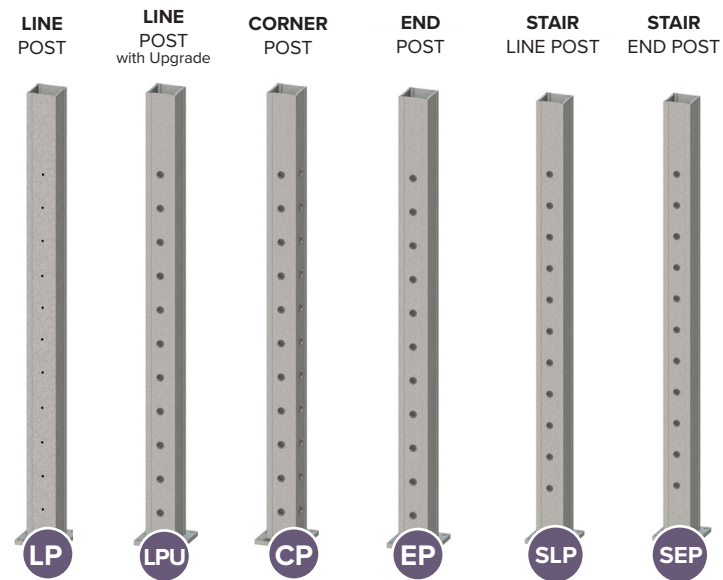

Stainless Steel Cable

Our horizontal cable rolls are available in stainless steel or black oxide finishes.

Cable Roll Lengths:

- 100'
- 250'
- 500'



VERTICAL CABLE SYSTEM

Cable comes pre-installed! Install the section, tighten the cable, and you're done.

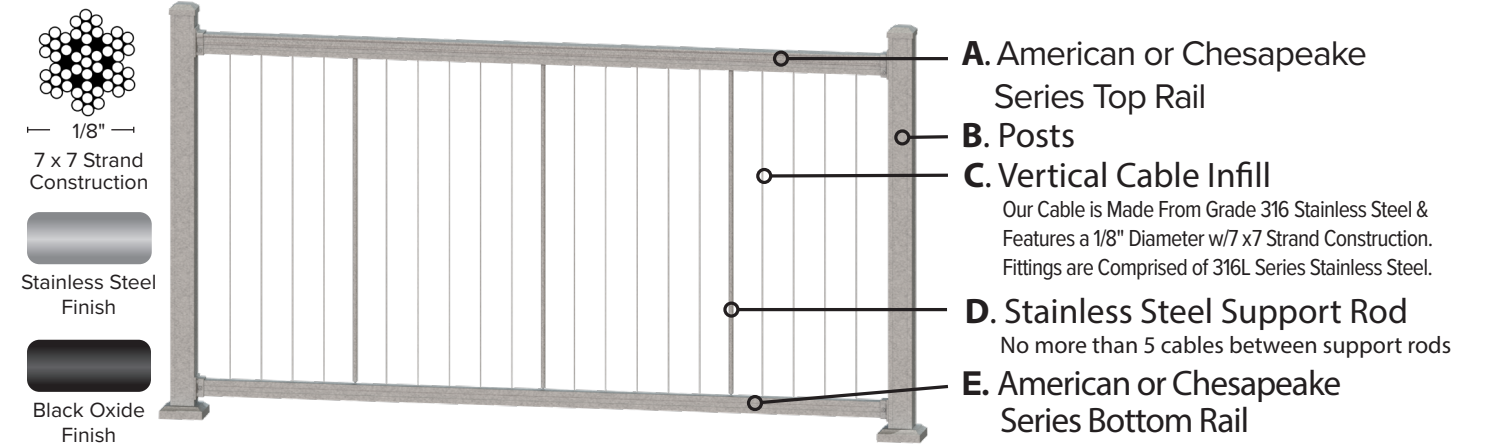

Boxed Section Includes: Top & bottom rails, balusters, mounting brackets with screws, and installation guide. 8' level sections include a section support. Posts, caps, and trim sold separately.

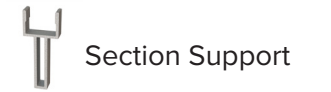

INSTALLATION TOOLS

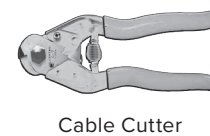
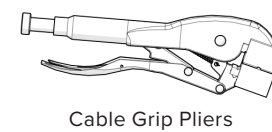
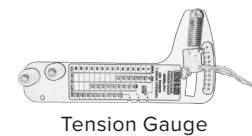

HORIZONTAL CABLE ONLY

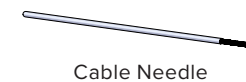
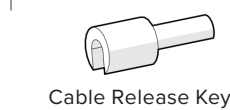

CLEANER & PROTECTANT

*For preventative care and cleaning. Sold as a kit.



See the cable railing cleaning guidelines on our website for more information.



AROUND THE BEND

GATES GALORE

Bend Sections for Chesapeake and American Series

Order your custom bend sections to create an eye-catching design. Provide a radius or a projection measurement and Keylink will create a bend section to fit!

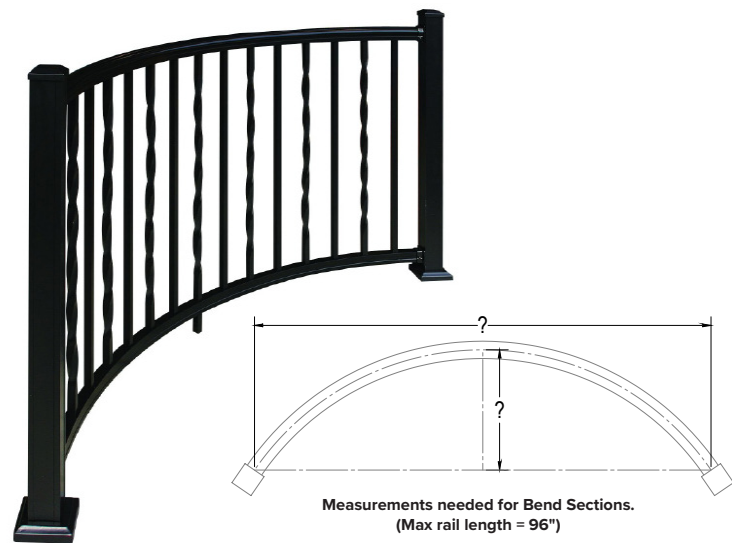

Available in the **Chesapeake** or **American** series in the following infills:

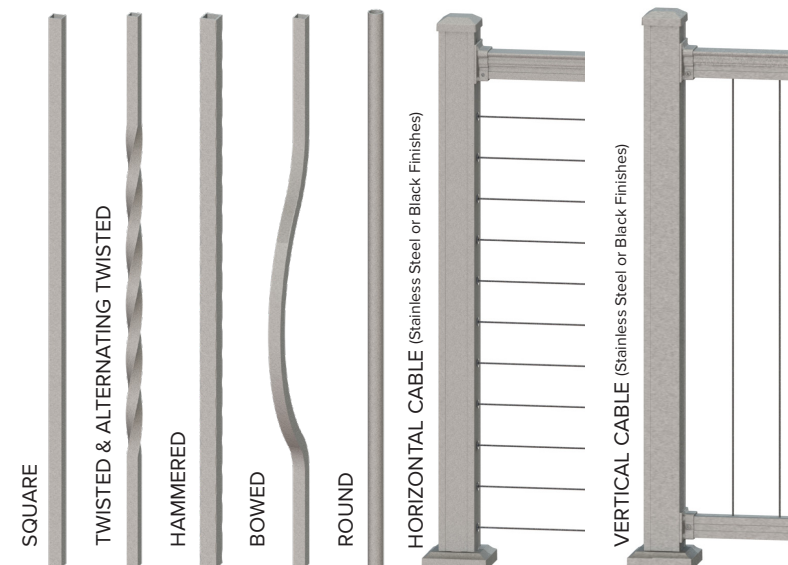

Adjustable Gate Kits

Keylink Adjustable Gate Kits are engineered for **installer convenience** and can be cut and assembled in the field. Standard size options will have you prepared to address most railing gate scenarios **quickly and efficiently**.

American and **Outlook** gates are available in: 36" x 36", 36" x 48", 42" x 36", and 42" x 48".

Discovery gates are available in: 36" x 36" and 36" x 48".

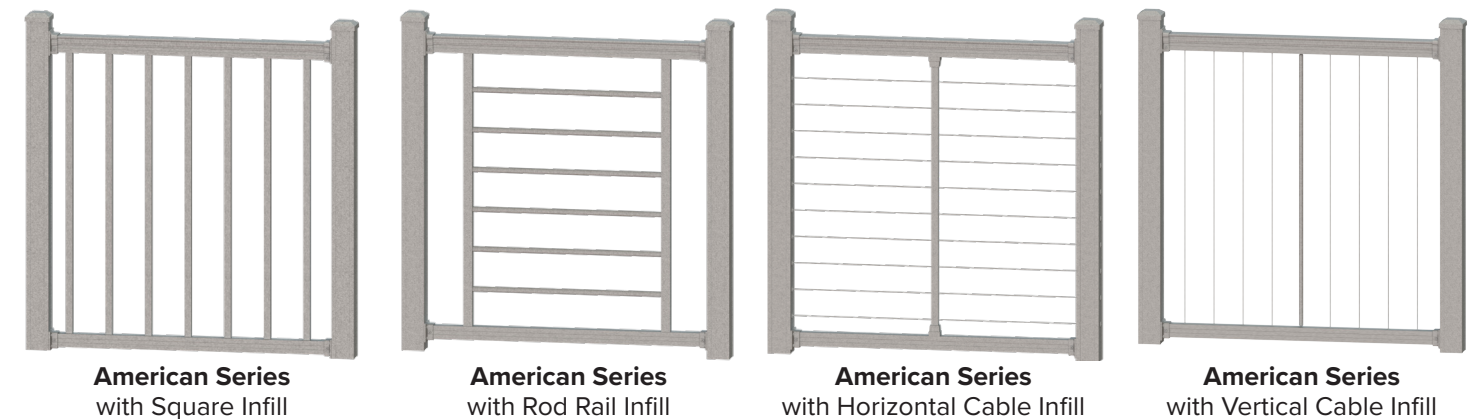

Chesapeake and Custom Gates

Need a gate for your Chesapeake railing or prefer a custom-built gate for an American or Outlook project? Keylink supplies installers with custom size gates to coordinate with our railing.

Each gate is built to your specifications for a perfect fit every time.

Chesapeake gates feature an over-the-post construction while American and Outlook are between-the-post.



WHAT'S YOUR ANGLE?

CHESAPEAKE SERIES BRACKETS & WEDGES

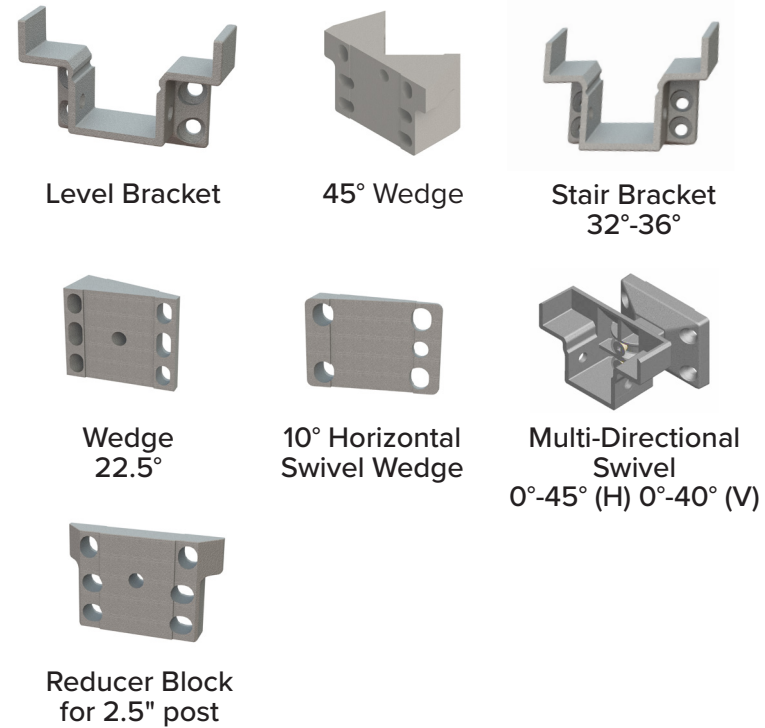

HORIZONTAL BRACKET ANGLE GUIDE

- Multi-Directional Swivel = 0°-45°
- Horizontal Swivel Wedge = +10°
- 45° Bracket = 45°
- Wedge = 22.5°

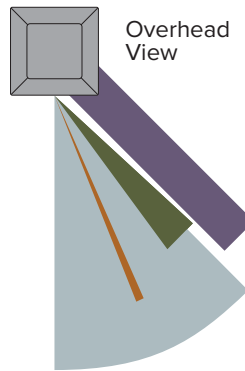

VERTICAL BRACKET ANGLE GUIDE

- Multi-Directional Swivel = 0°-45°
- Stair Wedge = 5°
- Stair = 32°-36°

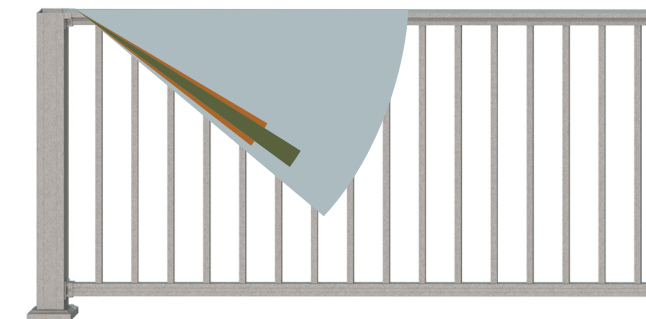

AMERICAN SERIES BRACKETS & WEDGES

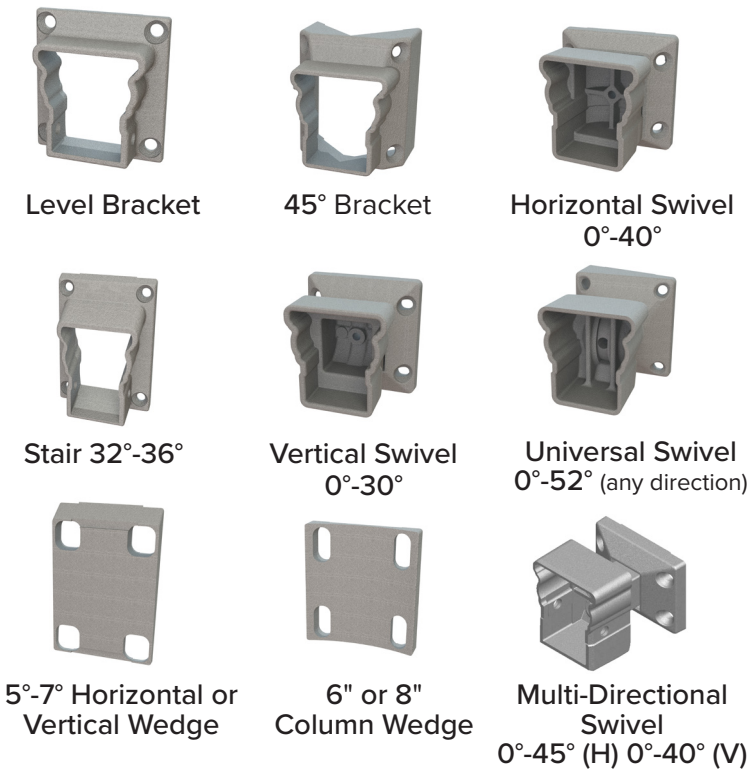

HORIZONTAL BRACKET ANGLE GUIDE

- Universal Swivel = 0°-52°
- Multi-Directional Swivel = 0°-45°
- Horizontal Swivel = 0°-40°
- 45° Bracket = 45°
- Horizontal Wedge = 5°-7°

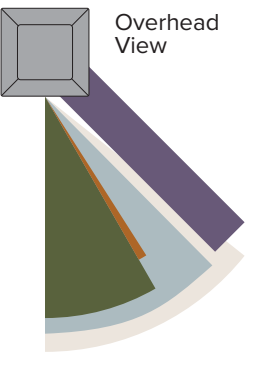

VERTICAL BRACKET ANGLE GUIDE

- Universal Swivel = 0°-52°
- Multi-Directional Swivel = 0°-40°
- Vertical Swivel = 0°-30°
- Stair = 32°-36°
- Vertical Wedge = 5°-7°

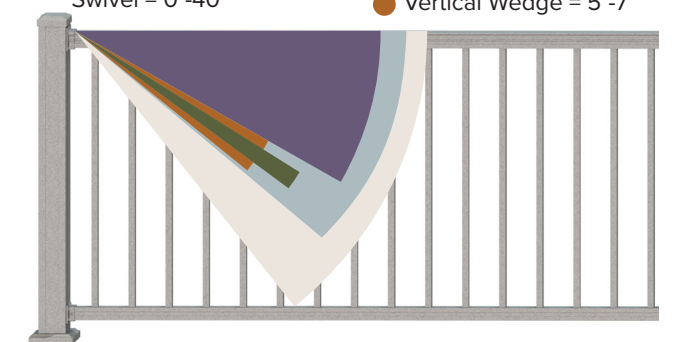

OUTLOOK SERIES BRACKETS & WEDGES

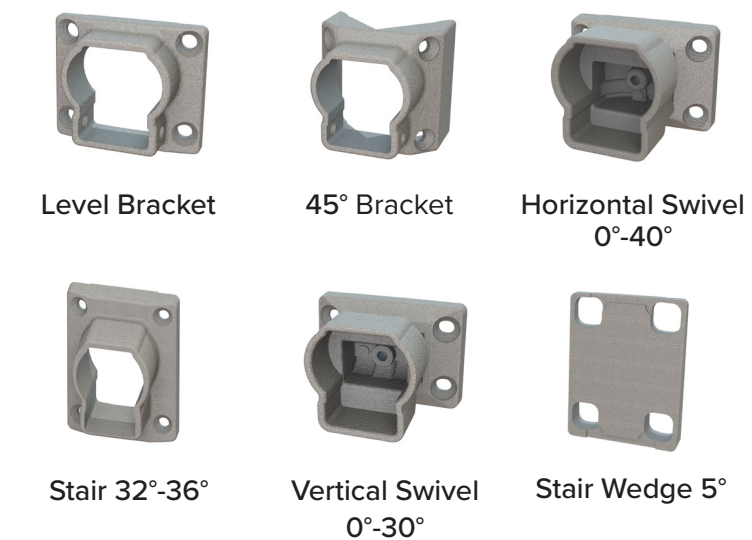

HORIZONTAL BRACKET ANGLE GUIDE

- Horizontal Swivel = 0°-40°
- 45° Bracket = 45°

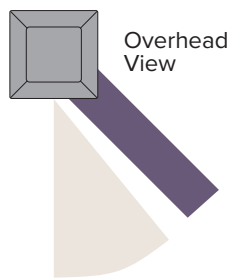

VERTICAL BRACKET ANGLE GUIDE

- Vertical Swivel = 0°-30°
- Stair Wedge* = 5°
- Stair = 32°-36°

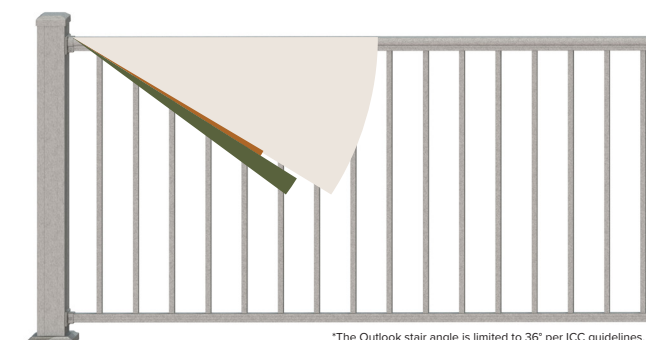

*The Outlook stair angle is limited to 36° per ICC guidelines.

DISCOVERY SERIES BRACKETS & WEDGES

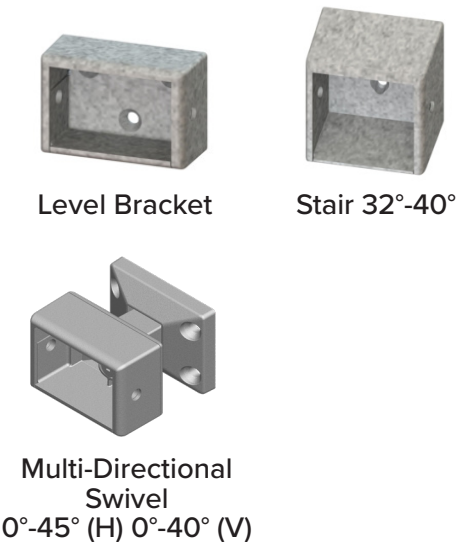

HORIZONTAL BRACKET ANGLE GUIDE

- Multi-Directional Swivel = 0°-45°

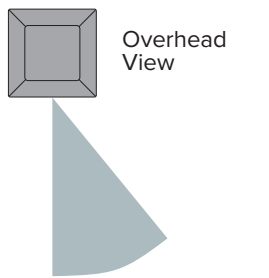

VERTICAL BRACKET ANGLE GUIDE

- Multi-Directional Swivel = 0°-40°
- Stair = 32°-40°

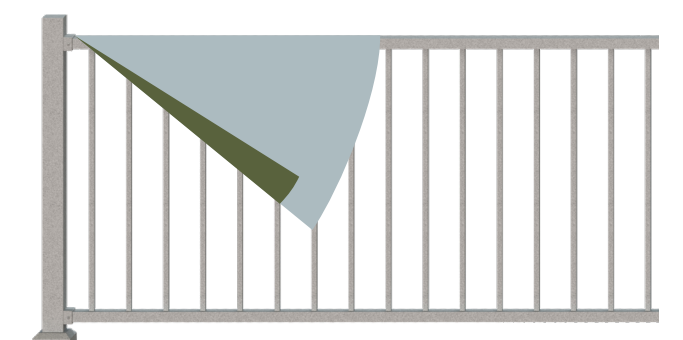

ACCESSORIES

FASCIA MOUNT BRACKETS

Move your posts from the top of the deck to the sides and **increase the square footage** of your outdoor living space!

- For every linear foot of fascia railing, gain ½ square foot of deck space
- Fascia brackets should be paired with fascia-specific posts
- Fascia mounted horizontal cable requires a fascia-specific sections, all other infills use standard sections
- Available for 2½” or 3¼” posts.
- For use on wood, concrete or composite fascia
- Available in all standard, special order and coastal upgrade finishes

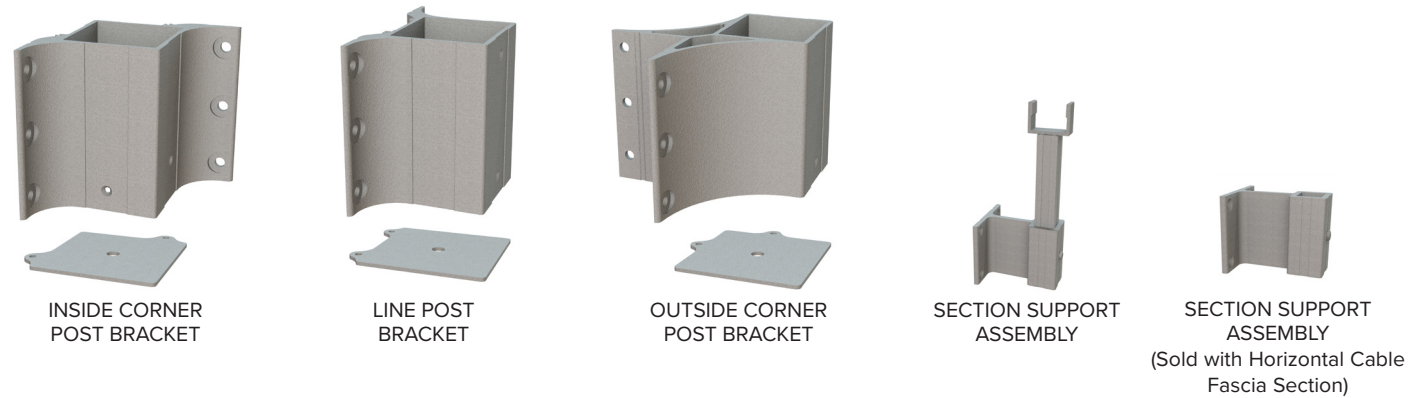

EXTERNAL CABLE FITTINGS

Cable fittings allow you to turn wood, aluminum, composite, or masonry posts into vehicles for beautiful on-trend horizontal cable railing.

These fittings have full tensioning capacity for safety and security and require only a few standard tools for installation.

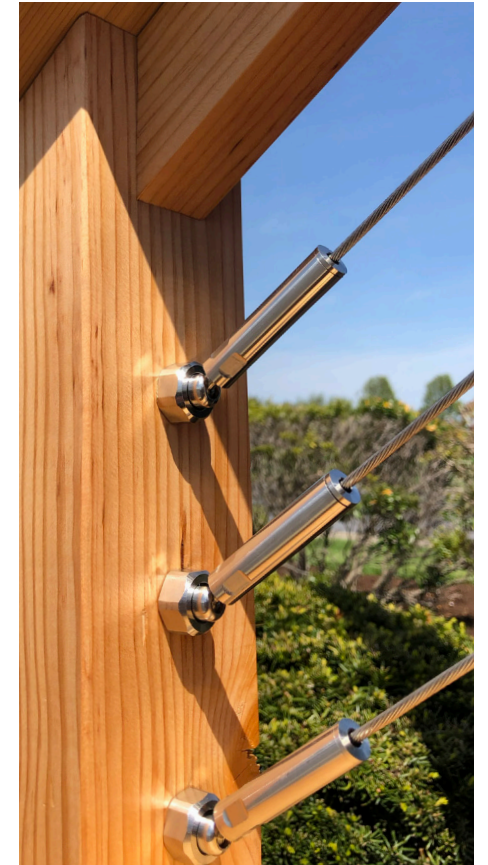
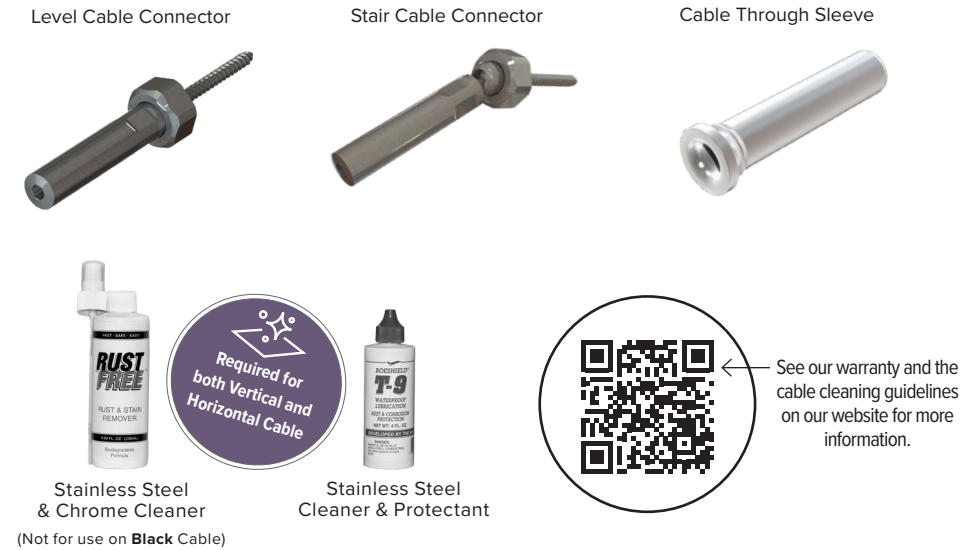

POST WRAP & STRUCTURAL COLUMNS

Complement your railing project with matching post wrap or support your porch roof with handsome powder-coated structural columns. All items are color matched to our railing lines, and unlike wood, these posts will not crack, rot, or ever need to be painted.

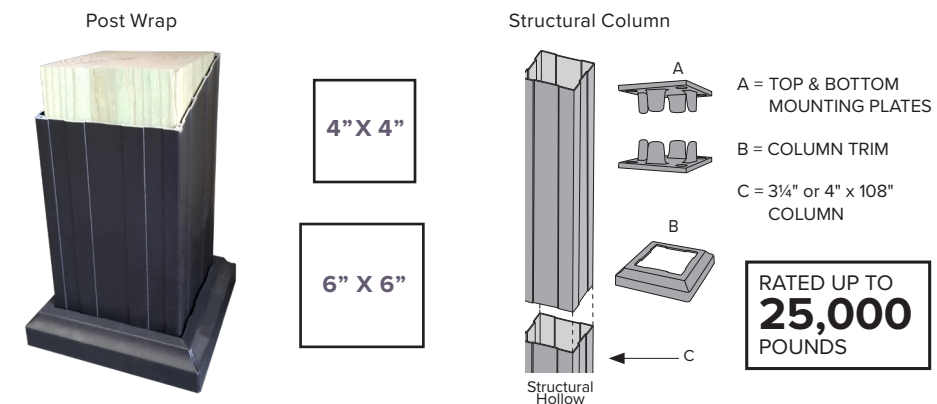

POST CAPS & TRIM



ALUMINUM HANDRAIL - ADA COMPLIANT

This handrail is designed to coordinate perfectly with Keylink's existing railing for a beautiful, functional, and safe railing system.



- The International Code Council A117.1 section 504.1 requires all stairs over 4 rises to have handrail on both sides of the stair
- Wall or post mount applications
- Installs easily with no painting or welding needed
- Available in all standard, special order and coastal upgrade finishes

STANDARD COLORS



SPECIAL ORDER COLORS



COASTAL UPGRADE COLORS

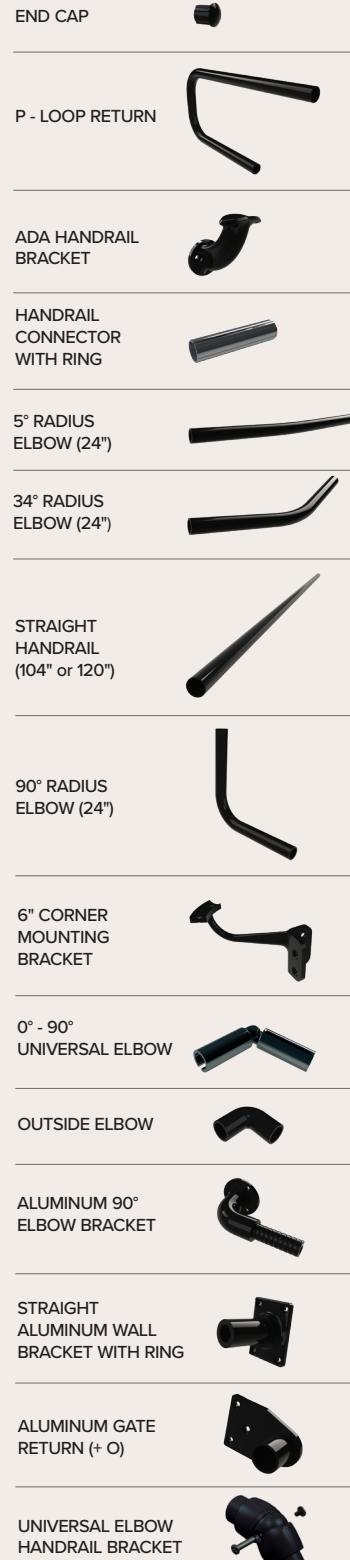
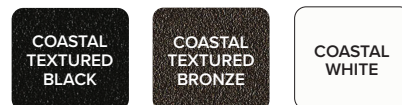

BRING YOUR SPACE TO LIGHT

Keylink's electrical engineers and experts have refined our lights for a long-lasting and easy-to-use system that brings exceptional outdoor lighting to your deck or porch.

STANDARD COLORS

Powder-coated die-cast aluminum

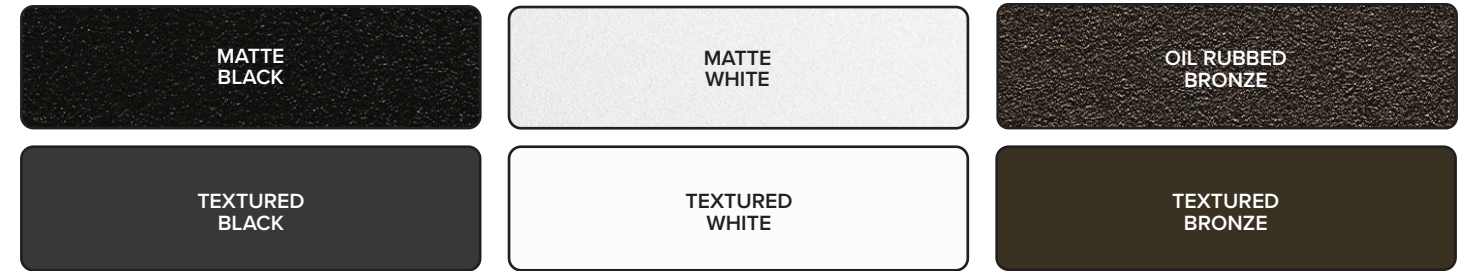

Scan the code to view our full collection of **colors and finishes** available for Special Order and Coastal Upgrade.



S = Satin Finish | G = Gloss Finish

POST & ACCENT LIGHTS

Sizes available for 2½", 3¼" and 4" Posts

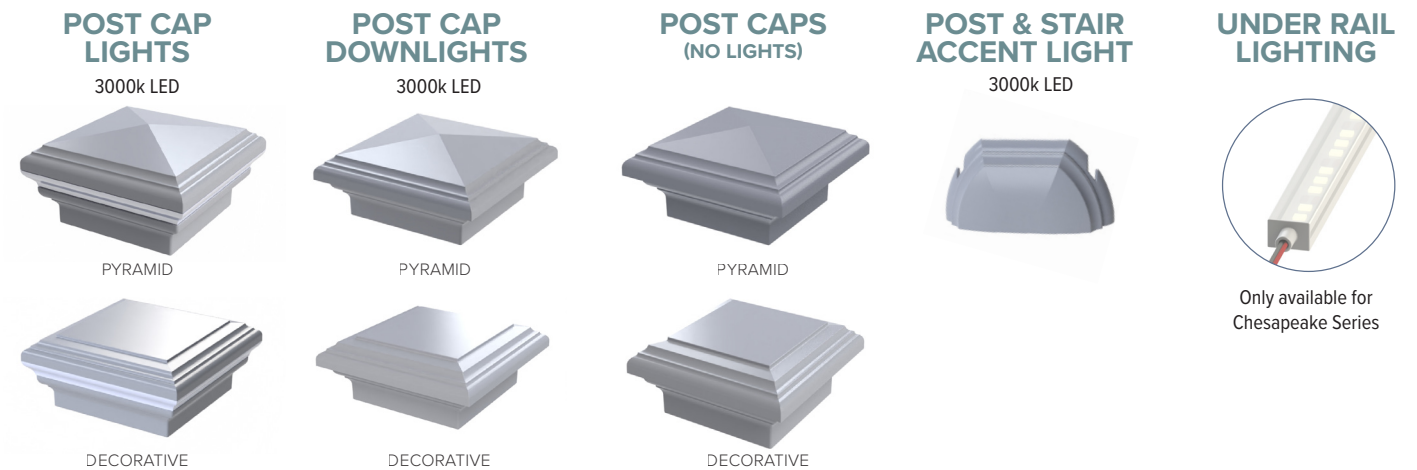

Only available for Chesapeake Series

LIGHTING ACCESSORIES

LIGHTING CONTROL HUB & POWER SUPPLY



- Timer lets you choose 1-9 hours of light, or dusk-to-dawn
- Dimmer mode with 9 brightness levels
- Adjustable photocell sensor to control for ambient light
- **Walk Away** feature for safe exiting before lights go out
- Aluminum housing to match railing
- Power Supply available in 60w or 120w
- Expandable Power Splitter available for both 60w or 120w power supply
- Available in all Standard Colors

POST LIGHT WIRE KIT

KIT INCLUDES:

- Staples
- 2-way splitter
- 5' and 9' wire extensions

WIRE EXTENSIONS, WIRE SPLITTERS

WIRE EXTENSIONS:

- 2', 5', 9' Lengths Available

WIRE SPLITTER KITS:

- 2-Way Kit: Includes (1) 8" input cable to (2) 8" output cables
- 3-Way Kit: Includes (1) 8" input cable to (3) 10" output cables

2" POST ADAPTER

- Made to fit fence posts
- Fits 2" Posts
- Uses 2½" Cap for 2" Post



KEYLINK



keylinkonline.com

110 Peters Road, New Holland, PA 17557

Toll Free: 888-704-7130

Email: info@keylinkonline.com



Visit us online



© Keylink | 260101